



Operating instructions

(Translation of the original operating instructions)

CO₂ measurement meter

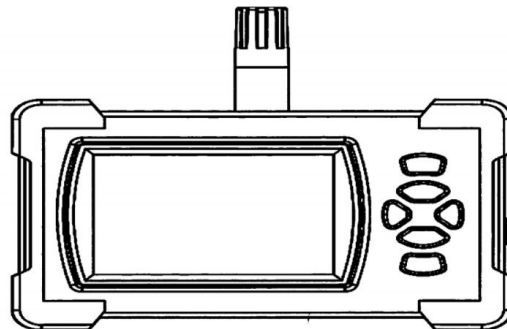

Table of contents

1. Overview	3
2. Safety and maintenance	3
3. The meter / Functions of the operating keys	4
4. Operation	5
4.1. Switching on and off	5
4.2. Changing the temperature unit	5
4.3. Switching the alarm function on and off	5
4.4. Setting the alarm value	5
4.5. Viewing the records	6
4.6. View / Changing settings	6
4.7. Viewing the data as a historical trend diagram (histogram)	8
4.8. Creating a PDF file	8
5. Technical data	10
6. Carbon dioxide concentrations	11
7. Explanation and elimination of frequently occurring errors	11

1. Overview

The carbon dioxide measuring meter measures the carbon dioxide (CO₂) concentration on site using the infrared absorption principle. The product has the following features: Temperature and humidity histograms, 999 records, 3.2-inch TFT colour display, alarm setting, records from periodic measurements, realtime data and time, rechargeable lithium battery or a separate external USB charger, sensor useful life over 8000 hours and stable data.

Usage scenarios for the carbon dioxide meter:

1. Public places

Highly frequented locations such as meeting rooms, classrooms, exhibition halls, hospitals, department stores, bars, hotels, airports, train stations, event halls and the like. The CO₂ meter can be used for ventilation control and monitoring ambient air, helping to check and maintain the health of the body.

2. Agriculture

Plants need CO₂ for photosynthesis, so it is often used in agriculture. CO₂ fertilisation in the right concentration can improve the growth of greenhouse crops. This "air fertilisation" raises the CO₂ concentration to an ideal level and improves the growth and quality of vegetables.

3. Animal husbandry

Air quality influences the healthy growth of animals. When the air is stale and carbon dioxide concentrations are high, animals can suffer adverse effects from the lack of ventilation and diseases can spread more easily. Installing a carbon dioxide meter can prevent the occurrence of animal diseases in livestock farms.

4. Industry

Carbon dioxide measuring meters are widely used in industry, in waste water treatment, for example, factory buildings, workshops and clean or air-conditioned rooms. They ensure safety in production for all branches of industry. Monitoring the CO₂ concentration is crucial, especially in borehole operations. The carbon dioxide meter is generally used in metalworking, paper and pulp manufacturing, cleaning and solvent extraction, cleaning with liquid or solid carbon dioxide and in other carbon dioxide-related work.

2. Safety and maintenance

- To avoid shortening the meter's useful life or damaging it, please do not use it in environments with dust or aggressive gases.
- If the battery symbol on the display is empty or red, please charge the battery as soon as possible. If the meter is not going to be used for a longer period of time, the battery must be removed.
- Please do not store or use the meter at high temperatures, in high humidity, near flammable or explosive substances and in strong electromagnetic fields.
- Use a soft cloth and neutral cleaning agents to care for and clean the housing. Never use abrasive cleaners or solutions – they can attack the housing and damage the meter.

3. The meter / Functions of the operating keys

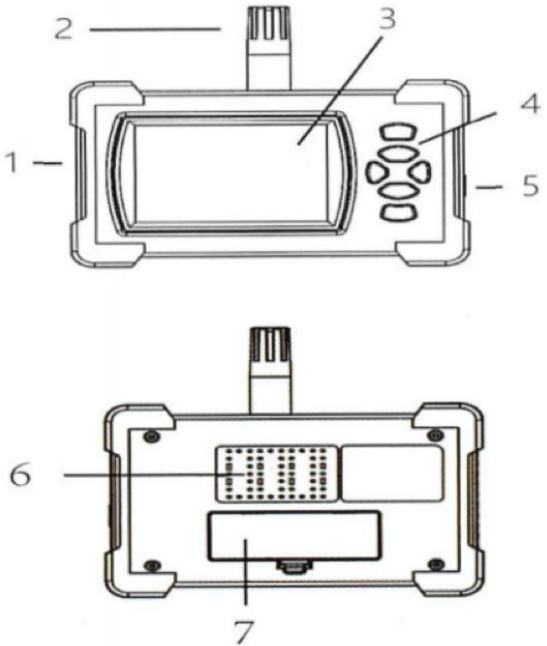
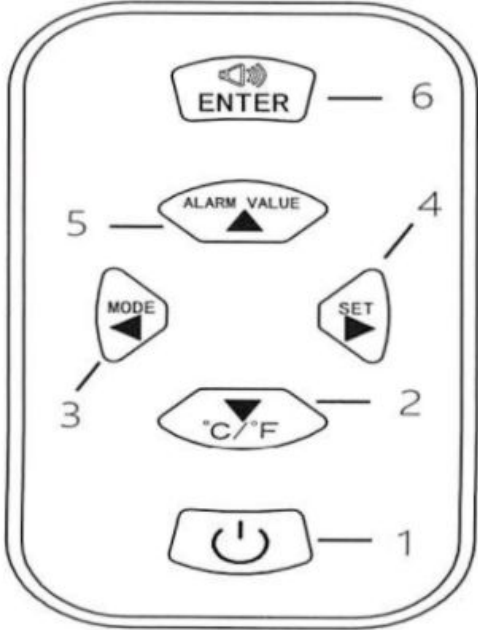
<p>Pos.1 Pos.2 Pos.3 Pos.4 Pos.5 Pos.6 Pos.7</p>	<p>Air opening Temperature and humidity sensor Display Operating buttons USB interface Air opening Battery compartment</p>		
<p>Pos.1 Pos.2 Pos.3 Pos.4 Pos.5 Pos.6</p>	<p>Measuring mode: ON/OFF Change temperature units Switch to the records view Records or setting Alarm setting view Switch the alarm sound on or off</p>	<p>Setting mode: ON/OFF Move down in the menu Set data off or smaller Select data or set larger Move up in the menu Select data or set smaller</p>	

 Make sure that the air openings are not blocked while measuring.

4. Operation

4.1. Switching on and off

In the Measurement view, press  to switch the meter on and off.





Fig: Measurement view

4.2. Changing the temperature unit

Press  in the Measurement view to switch between °C and °F.

4.3. Switching the alarm function on and off

Press  in the Measurement view to turn the alarm function on and off. The  icon appears at the top of the screen when the alarm function is on. It is not displayed if the alarm function is switched off.

4.4. Setting the alarm value













Press  in the Measurement view to open the alarm value setting view. Press   to select the value, press   to increase or decrease the value, press  to save and exit after setting.



Fig: Setting the alarm value

4.5. Viewing the records

Press  once in the measurement view to switch to the Records view. Press  in the Records view. The page number is displayed at the bottom. Press  and  to move left and right, press   to set the page number and press  again to exit.

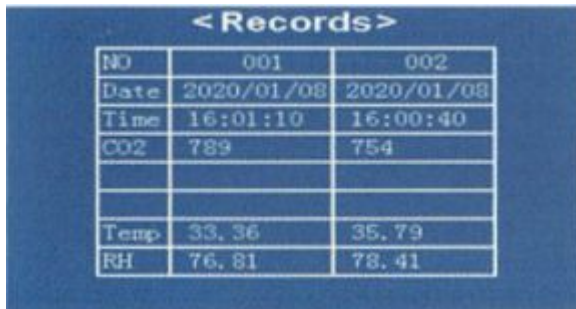

<Records>		
NO	001	002
Date	2020/01/08	2020/01/08
Time	16:01:10	16:00:40
CO2	789	754
Temp	33,36	35,79
RH	76,81	78,41

Fig: Records view



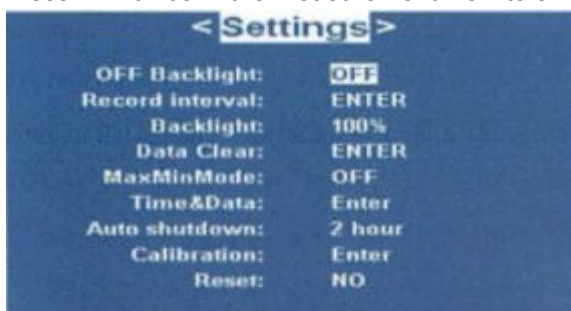

4.6. View / Changing settings

Press  twice in the Measurement view to switch to the Parameter view.

















<Settings>	
OFF Backlight:	OFF
Record interval:	ENTER
Backlight:	100%
Data Clear:	ENTER
MaxMinMode:	OFF
Time&Data:	Enter
Auto shutdown:	2 hour
Calibration:	Enter
Reset:	NO

Fig: Parameter view

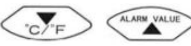
Setting parameters: Press  in the Parameter view. The adjustable parameters can be selected. Then press   to select the parameter to be set. Please refer to the following table for the operating steps. When the settings are complete, press  to exit Settings and press  to return to the Measurement view

Please note: The product has already been calibrated at the factory and can be used immediately. Please do not recalibrate the product unless the meter is displaying significant measurement errors. Calibration must be carried out in an environment with a CO2 concentration of 400 ppm (parts per million)!

Adjustable parameters	Adjustable values	Operating steps
Switching off the backlight	OFF / 1 min / 5 min / 10 min / 30 min / 1 h	
Measurement interval		Press  to access the setting options, press  to select and press  to exit.
Backlight	25 % / 50 % / 75 % / 100 %	
Delete data	Yes / No	
Min-Max view	ON / OFF	
Time and date	Date: 2020-10-30 Time: 10 : 01 : 18	Press  to enter the Time Setting view, press  again to select and press  to set. Press  to save the settings and exit.
Automatic switch-off	OFF / 15 min / 30 min / 45 min / 1 h / 2 h / 4 h / 8 h	
Calibration	Calibrate the unit in an environment with a CO2 concentration of 400 ppm. The calibration time of 600 seconds is counted down. After calibration, the unit will automatically return to the Measurement view.	
Reset	Yes / No	

4.7. Viewing the data as a historical trend diagram (histogram)



In the Measurement view, press  once to open the histogram (the meter must have saved measurement data, otherwise the histogram cannot be displayed).



Fig: Histogram

4.8. Creating a PDF file

Press  twice in the Measurement view to open the view as shown in the figure below. In this view, you can create a PDF file, connect the meter to a computer and format a disk.



Press  to select "Export PDF" and press  to create a PDF file.



Fig: PDF generator

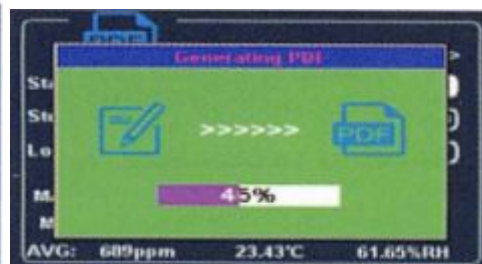

Fig: Generating PDF





Connect the meter to a computer using a USB data cable. Press  to select "Connect to USB" and press  to confirm the connection. When the connection has been made successfully, the computer displays a data carrier named "CO2 METER". Open this data carrier to view and copy the PDF file you created earlier.



Fig.: Connecting to the PC interface



Fig.: Data carrier recognised

Briefly press the ON/OFF button on the meter to disconnect it from the computer, press  to select "SHIFT" and press  to return to the Measurement view.





Formatting the data carrier: Press  to select "Formatted disk", press  to display the relevant dialogue box, and press  to format the disk or press  to cancel disk formatting.



Fig: Formatting a data carrier (disk)

5. Technical data

Parameter	Value / Explanation
Measuring range of CO ₂ concentration	0–9999 ppm
Measurement resolution of CO ₂ concentration	1 ppm
Measurement accuracy	±10 % of reading but not more than ±40 ppm
Operating temperature range	-10 to +60 °C (-4 to +140 °F)
Operating humidity range	0 to 99 % rel. humidity
Storage temperature range	-40 to +80 °C
Temperature measuring range	-20 to 60 °C
Temperature measurement accuracy	±1 °C
Temperature measurement resolution	0,01 °C or °F
Humidity measuring range	0 to 110% rel. humidity
Humidity measurement accuracy	±2 % rel. humidity
Humidity measurement resolution	0.01 % rel. humidity
Power supply	Built-in removable 3.7 V / 18650 cylinder battery or externally connected 5 V USB power supply
Operating current	180-300 mA
Battery capacity and life	2200 mAh for over 9 h continuous operation
Charging duration	3 h
Automatic switch-off	Adjustable (the factory setting is automatic switch-off after fifteen minutes)
Number of storable records	999 records
Net weight	191 g
Dimensions	140 × 134 × 33 mm

6. Carbon dioxide concentrations



400-450 ppm (excellent) – normal value outdoors

450-700 ppm (good) – typical value for a well-ventilated living space

700-1000 ppm (low level) – living environment with poor ventilation

1000-2000 ppm (medium level) – lack of oxygen leads to fatigue and can cause discomfort.

2000-5000 ppm (high level) – stale, old, warm and humid air can cause headaches, fatigue, a lack of concentration, declining alertness, heart palpitations and mild nausea.

Above 5000 ppm (highest level) – can cause severe oxygen deprivation, permanent brain damage, coma and even death when inhaled.

7. Explanation and elimination of frequently occurring errors

- **Incorrect or inaccurate readings of CO₂ concentration in the air.**
Explanation 1 – the concentration in the environment is not stable. Leave the meter in the same place for some time while measuring.
Explanation 2 – there are impurities in the air opening of the CO₂ sensor. The air opening is blocked.
Explanation 3 – measurement fault at the CO₂ sensor. The unit must be recalibrated.
- **Wrong temperature and humidity**
Explanation 1 – contamination or dirt in the air opening of the temperature and humidity sensor.
Explanation 2 – the air opening is blocked.
- **Wrong date and/or time**
Explanation 1 – the voltage of the button battery in the unit is too low.
- **Malfunction when switching on**
Explanation 1 – the battery is empty or damaged. Use the USB socket for the power supply. If the current can be switched on and something changes during the voltage test, this indicates that the battery is not supplying voltage. If there is no change, the OK symbol only indicates that the battery is damaged.
Explanation 2 – the poles of the battery (plus/minus) are reversed. Note that the flat contact at one end of the battery is the negative terminal and the protruding contact at the other end is the positive terminal. Please refer to the illustration on the meter.